



Green Electrical Supply

maximize your green[®]

www.GreenElectricalSupply.com



D530C150UVT-F



530mA LED Driver w/ Tuning

- Universal Input Voltage 120 – 277 Vac
- 0-10V Dimming to 10%
- Thermal Foldback Control

Performance

Input Voltage	120 ~ 277 Vac
Input Current Max	1.40 /120V 0.59/277V
Input Power Max	165W /120V 161W/277V
Input Frequency	50 - 60 (Hz)
Power Factor	> 0.95
THD max	< 20 %
Output Voltage	99V-285V
Output Current	53-530mA
Output Power	150W Max
Line Regulation	±1 %
Load Regulation	±3 %
Output Current Ripple	<10%
Inrush Current	120V: 31A / 210uS
Peak / >50% Duration	277V: 74A / 200uS

- * Refer to charts for additional information
- Harmonic Emissions comply with ANSI C82.77
- Inrush current complies with NEMA 410

Environmental

EMI and RFI	Meets FCC part 15 (Class A) Non-Consumer Limits
Minimum Operating Temperature	-40°C (-40°F)
Storage Temperature	-40°C to 85°C (-40°F to 185°F)
tc	85°C (185°F) max
Location Rating	UL Dry & Damp, Type HL
Transient Protection	IEEE C62.41 6kV**

**Driver uses MOVs for transient protection.

Refer to application note EVD07 at www.unvlt.com for additional information on Hi-Pot Testing.

Physical

Length	9.50 in (241.3 mm)
Width	2.40 in (61.0 mm)
Height	1.55 in (39.4 mm)
Mounting Length	8.89 in (225.8 mm)
Weight (lbs)	2.6
Lead Lengths	
Blk, Wht, Blk/Wht, Blu/Wht	11.5 +/- 1.0 in
Red(+), Blue(-), Gry, Prp	11.5 +/- 1.0 in

Lead-wires are 18 AWG 105°C /600V solid copper.

Protection

Over voltage, Overload and short circuit, over temp.

Safety:

UL 8750 & CSA 250.13
UL Class P

Ordering Information

Order Number	Description	Qty/Carton
D530C150UVT-F20KC	Standard Product	10
D530C150UVT-FR00C	Rated IP66	10

*Consult Factory for Tuning ordering information

Wiring Diagram:

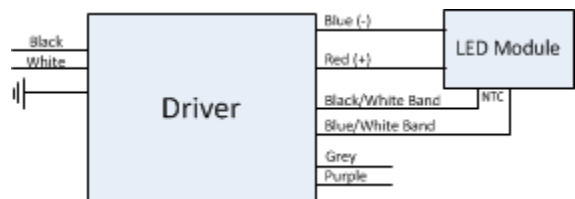

- **NOTE:** Unused Black/White and Blue/White leads must be individually capped off when thermal foldback control is not used.



Application and operation performance specification information subject to change without notification.



D530C150UVT-F

Programmable Tuned Output Settings

- This Everline LED Driver can be configured to set its current output to a selected fraction of their maximum rated design level. This function is called tuning (or also high-end trim) and it can be implemented with the LDTC01A using the Selector rotary switches. Tuning assignments are stored in driver memory and are not lost when power is removed. All factory produced drivers are tuned to maximum output unless otherwise noted on the label.
- Tuning SET Levels are listed in the table to the right. The SET Level corresponds to an associated Output Current value.
- Tuned output tolerance of $\pm 5\%$.
- Refer to application note EVD06 at www.unvlt.com for additional information.

Set Value	Output Current (A)
100	0.530
99	0.523
98	0.516
97	0.509
96	0.502
95	0.496
94	0.489
93	0.482
92	0.475
91	0.469
90	0.462
89	0.455
88	0.449
87	0.442
86	0.436
85	0.429
84	0.423
83	0.416
82	0.410
81	0.404

Set Value	Output Current (A)
80	0.397
79	0.391
78	0.385
77	0.379
76	0.372
75	0.366
74	0.360
73	0.354
72	0.348
71	0.342
70	0.337
69	0.331
68	0.325
67	0.319
66	0.314
65	0.308
64	0.302
63	0.297
62	0.291
61	0.286

Set Value	Output Current (A)
60	0.280
59	0.275
58	0.270
57	0.264
56	0.259
55	0.254
54	0.249
53	0.244
52	0.239
51	0.234
50	0.229
49	0.224
48	0.219
47	0.214
46	0.210
45	0.205
44	0.200
43	0.196
42	0.191
41	0.187
40	0.183



Application and operation performance specification information subject to change without notification.



0-10V Dimming

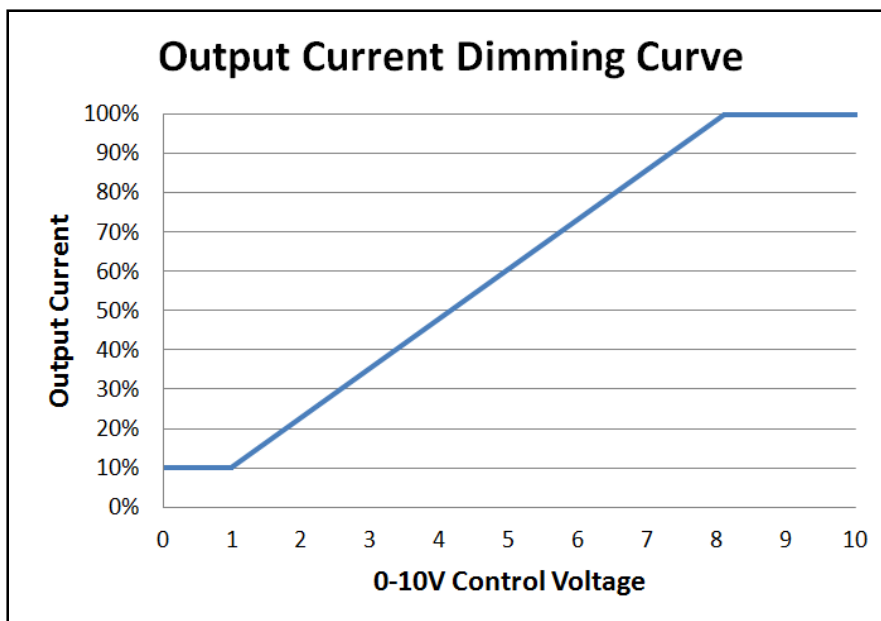

0-10V Analog Dimming Interface

- Analog 0 to 10 vDC Voltage Control
- Use Violet (+) & Gray (-) for connection to 0-10vDC.
- 10v = maximum output, 0v = minimum output
- Wiring Violet & Gray together provides min. light output.
- Capping Violet & Gray separately provides 100% light output.
- 0-10V interface can be wired as Class 1 or Class 2 Circuit.
- Driver will source a maximum of 200uA for control needs.
- Controller must sink current from the 0-10V control leads.

EVERLINE™

Application and operation performance specification information subject to change without notification.



Performance: Efficiency, THD, & Power Factor

Typical performance measurements are shown. The charts are to be used as a guideline and not for specification use.

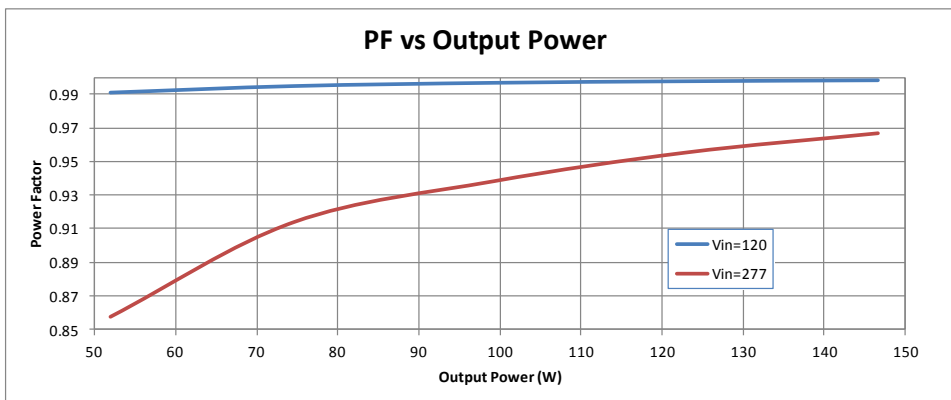
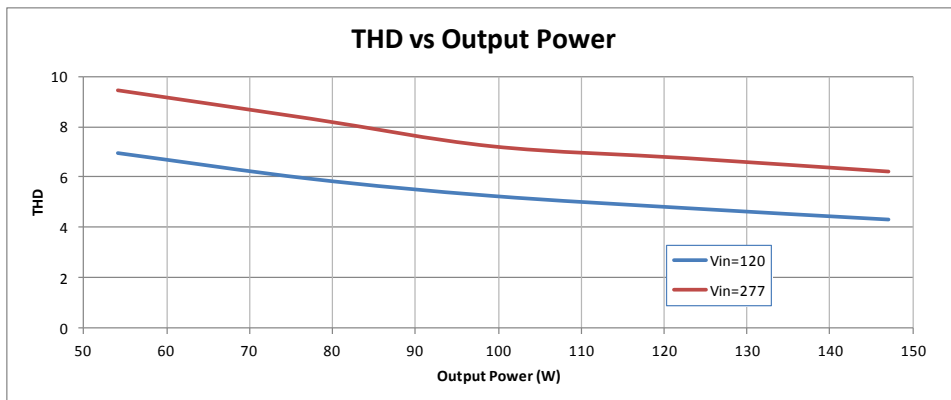
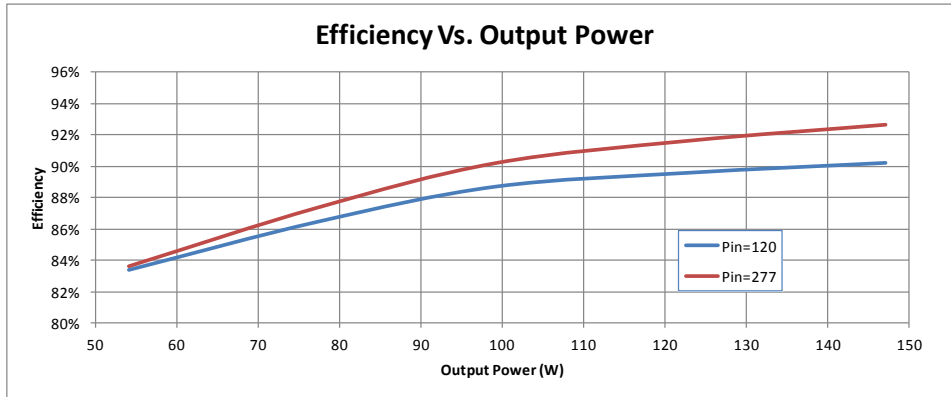

Output power based on maximum rated output current and varying load voltages.



Application and operation performance specification information subject to change without notification.



Module Thermal Foldback Protection

Thermal Foldback Control

- Luminaire temperature monitoring/protection
- LED Driver reduces output current for external thermal protection if an NTC (Negative Thermal Coefficient) is connected to the Black/White and Blue/White leads.
- **NOTE:** Unused Black/White and Blue/White leads must be individually capped off when thermal foldback control is not used.
- See application note on www.unvlt.com for more information.

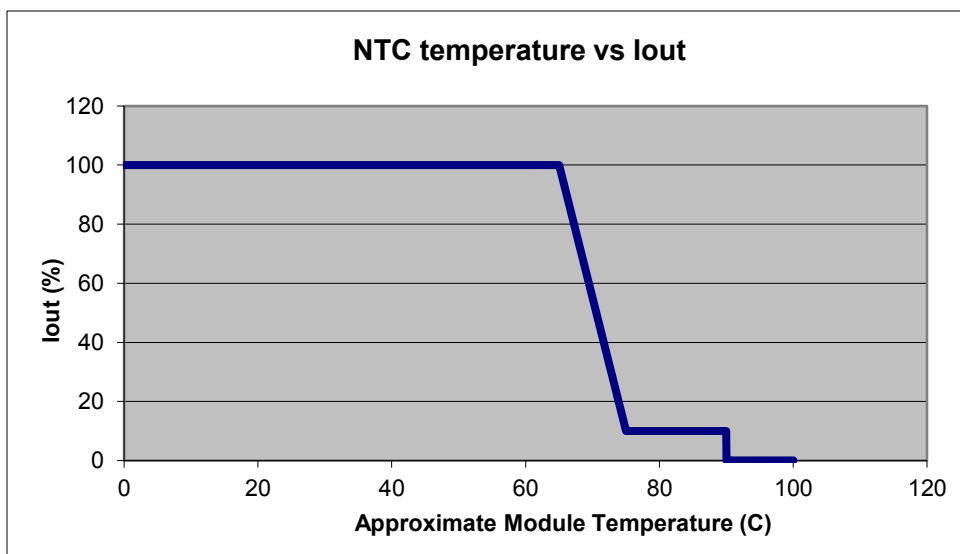

(Example with the Murata NTC p/n NCP18XV103J03RB)



Application and operation performance specification information subject to change without notification.



D530C150UVT-F

Life Rating Prediction

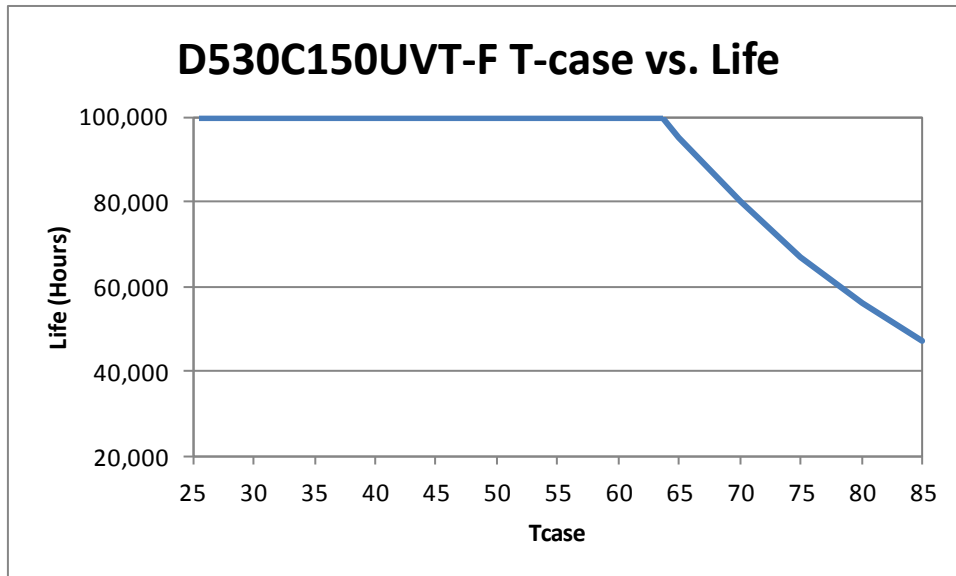

The Data curve provided predicts the LED Driver life based on the case temperature measured at the Tc location identified on the label or specification sheet. The Telecordia SR-332 standard is used to generate the prediction curves.

Dimensional Diagram

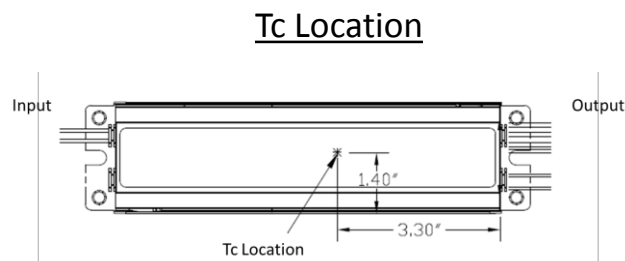
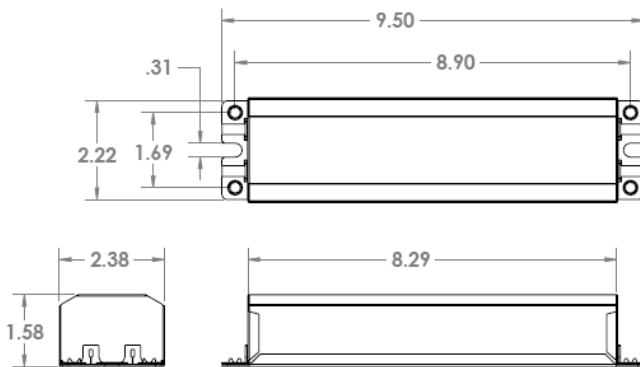

Warranty:

Universal Lighting Technologies warrants to the purchaser that each power supply will be free from defects in material or workmanship for a period of 5 years from the date of manufacture when properly installed per instructions and under normal operating conditions of use. Call 1-800-225-5278 for technical assistance.



Application and operation performance specification information subject to change without notification.